

# **42<sup>nd</sup> Annual Jim Bair Invitational**

January 9, 2016

Castle Rock High School

Castle Rock, WA

## **Team Scores**

1. Castle Rock	247.5
2. Ilwaco	200.0
3. Eatonville	159.5
4. Castle Rock 2	113.0
5. Union	85.0

## **Placers**

Aaron Avery	2nd	106
Brandon Esperto	3rd	106
Daniel Avery	3rd	113
Michael Rogers	5th	126
Austin Huynh	5th	152
Noah Hadfield	5th	152
Scott Smith	5th	160
Joshua Joo	5th	182

42ND ANNUAL JIM BAIR INVITATIONAL  
 Weight class : 106

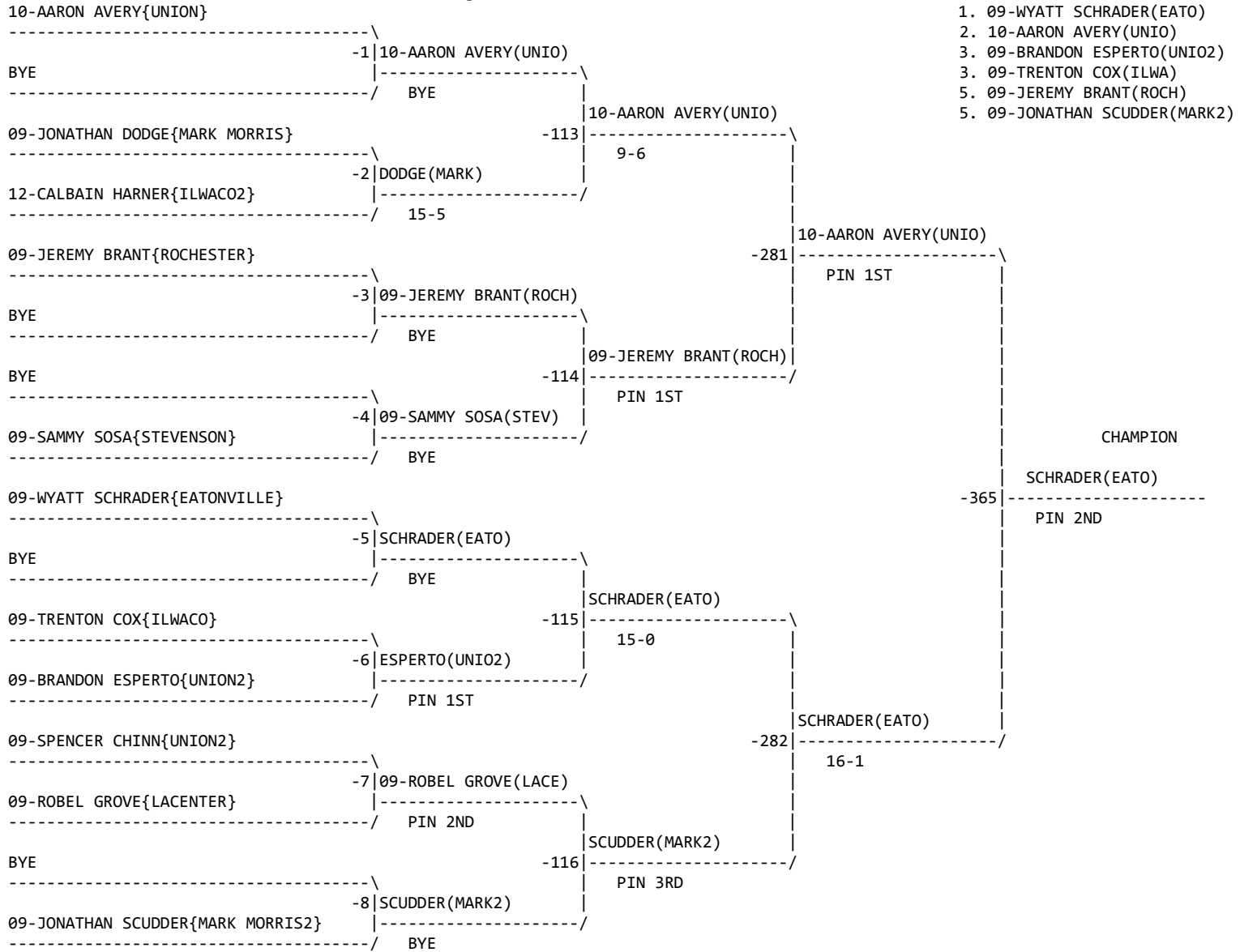

1. 09-WYATT SCHRADER(EATO)
2. 10-AARON AVERY(UNIO)
3. 09-BRANDON ESPERTO(UNIO2)
3. 09-TRENTON COX(ILWA)
5. 09-JEREMY BRANT(ROCH)
5. 09-JONATHAN SCUDDER(MARK2)

Consolation for Weight class : 106

Line	Weight	Name	Score	Weight	Name	Score	Rank
		09-ROBEL GROVE(LACE)			09-JEREMY BRANT(ROCH)		
		L-116		L-281			Third
BYE		09-ROBEL GROVE(LACE)		ESPERTO(UNIO2)			
-----		-225		-337			
L-1		HARNER(ILWA2)	17-4	ESPERTO(UNIO2)			PIN 3RD
	-117	BYE		-283			
HARNER(ILWA2)		ESPERTO(UNIO2)		17-9			
-----							
L-2							
		L-115		ESPERTO(UNIO2)			
BYE		-226					
-----							
L-3		BYE	BYE				
	-118						
BYE		BYE					
-----							
L-4		09-SAMMY SOSA(STEV)		SCUDDER(MARK2)			
		L-114		L-282			Third
BYE		09-TRENTON COX(ILWA)		09-TRENTON COX(ILWA)			
-----		-227		-338			
L-5		09-TRENTON COX(ILWA)	PIN 2ND	09-TRENTON COX(ILWA)			PIN 3RD
	-119	BYE		-284			
09-TRENTON COX(ILWA)		DODGE(MARK)		9-1			
-----							
L-6							
		L-113		CHINN(UNIO2)			
CHINN(UNIO2)		-228					
-----							
L-7		CHINN(UNIO2)	PIN 3RD				
	-120						
BYE		BYE					
-----							
L-8							

42ND ANNUAL JIM BAIR INVITATIONAL

Weight class : 113

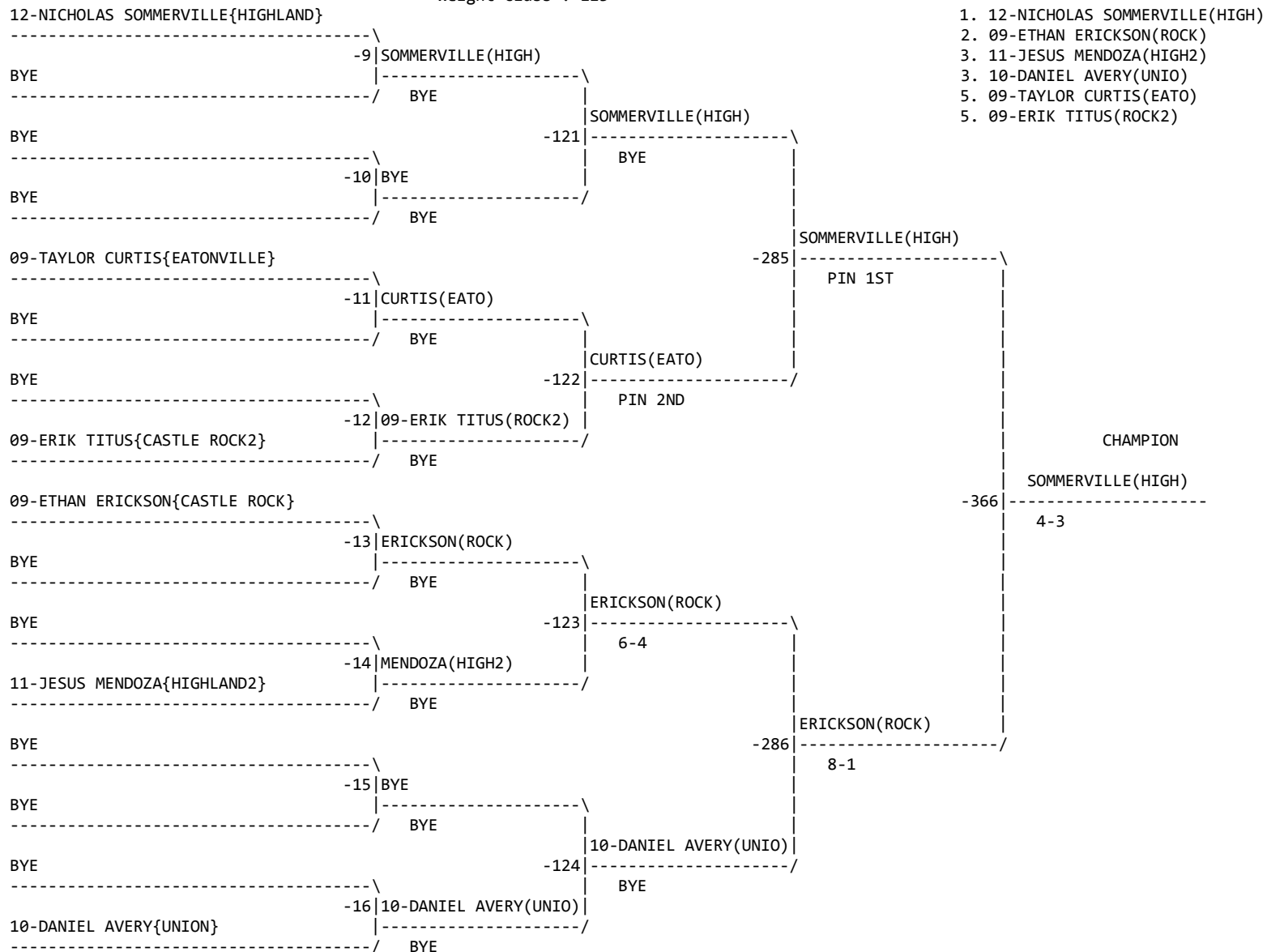

Consolation for Weight class : 113

```

                                BYE
                                -----\
                                L-124 | BYE
                                -----\
BYE L-9 | BYE -229 | BYE
-----\
-125 | BYE | BYE -339 | MENDOZA(HIGH2)
-----\
BYE | BYE | MENDOZA(HIGH2) | 19-0
-----/
L-10 | MENDOZA(HIGH2) | BYE |
-----/
-287 | MENDOZA(HIGH2) |
-----/
BYE L-11 | L-123 | MENDOZA(HIGH2) |
-----\
-126 | BYE | BYE -230 |
-----\
BYE | BYE | BYE
-----/
L-12 | 09-ERIK TITUS(ROCK2)
-----\
BYE L-122 | 09-ERIK TITUS(ROCK2)
-----\
L-13 | BYE -231 | BYE
-----\
-127 | BYE | BYE -340 | 10-DANIEL AVERY(UNIO)
-----\
BYE | BYE | 09-ERIK TITUS(ROCK2) | 8-0
-----/
L-14 | BYE | BYE -288 |
-----/
BYE L-15 | L-121 | BYE
-----\
-128 | BYE | BYE -232 |
-----\
BYE | BYE | BYE
-----/
L-16
```

42ND ANNUAL JIM BAIR INVITATIONAL

Weight class : 120

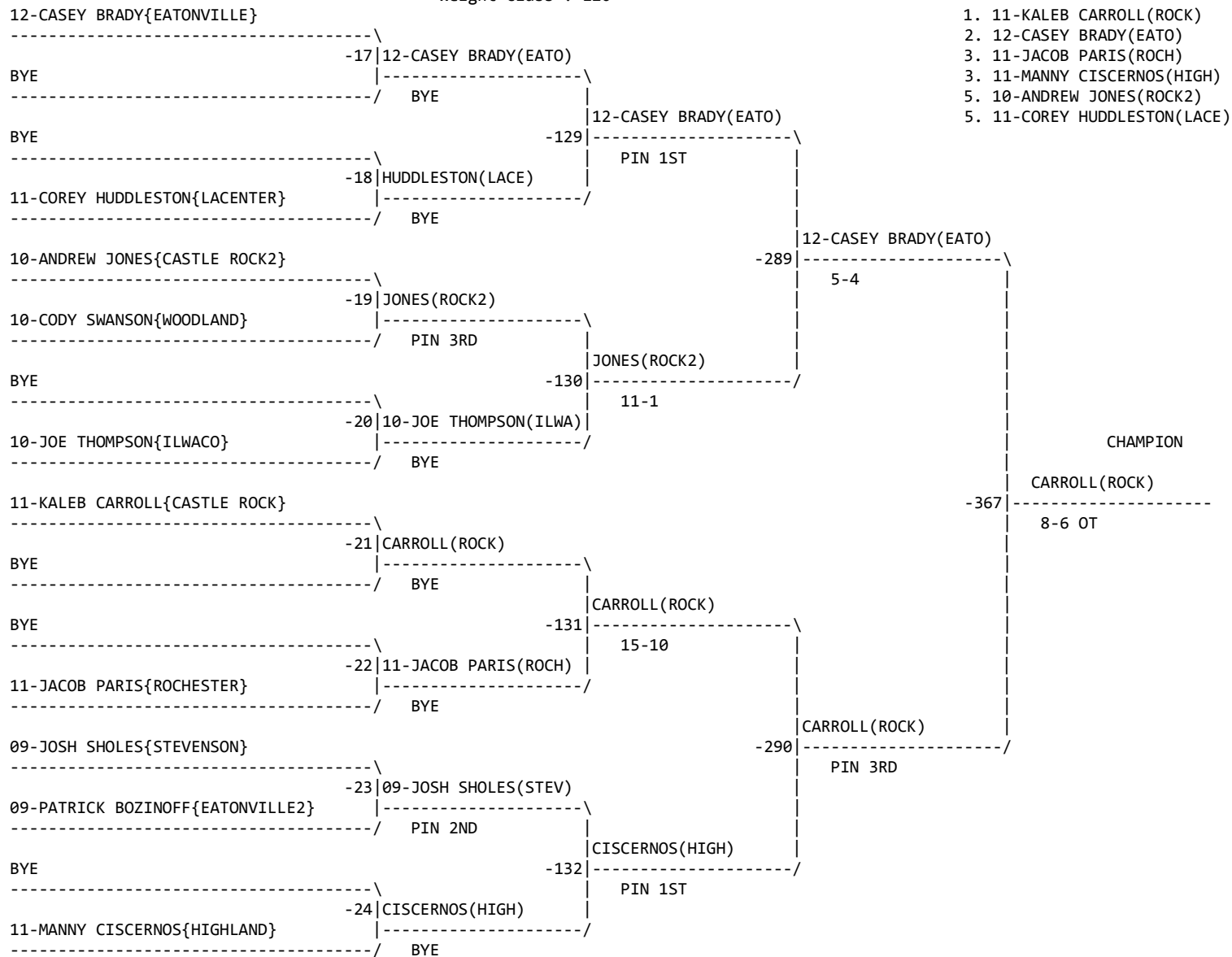

1. 11-KALEB CARROLL(ROCK)
2. 12-CASEY BRADY(EATO)
3. 11-JACOB PARIS(ROCH)
3. 11-MANNY CISCERNOS(HIGH)
5. 10-ANDREW JONES(ROCK2)
5. 11-COREY HUDDLESTON(LACE)

Consolation for Weight class : 120

		09-JOSH SHOLES(STEV)		JONES(ROCK2)	
		-----\		-----\	
		L-132		L-289	
BYE					Third
-----\		-233		-341	
L-17	BYE		BYE		11-JACOB PARIS(ROCH)
-----\		-133		-291	10-6
BYE	BYE				
-----\					
L-18		11-JACOB PARIS(ROCH)		PIN 1ST	
-----\					
10-CODY SWANSON(WOOD)	L-131		11-JACOB PARIS(ROCH)		
-----\		-234			
L-19	10-CODY SWANSON(WOOD)		PIN 2ND		
-----\		-134			
BYE	BYE				
-----\					
L-20		10-JOE THOMPSON(ILWA)		CISCERNOS(HIGH)	
-----\					
BYE	L-130		10-JOE THOMPSON(ILWA)		Third
-----\		-235		-342	
L-21	BYE		BYE		CISCERNOS(HIGH)
-----\		-135			PIN 2ND
BYE	BYE				
-----\					
L-22		HUDDLESTON(LACE)		HUDDLESTON(LACE)	
-----\					
BOZINOFF(EAT02)	L-129		HUDDLESTON(LACE)		
-----\		-236			
L-23	BOZINOFF(EAT02)		PIN 2ND		
-----\		-136			
BYE	BYE				
-----\					
L-24					

42ND ANNUAL JIM BAIR INVITATIONAL

Weight class : 126

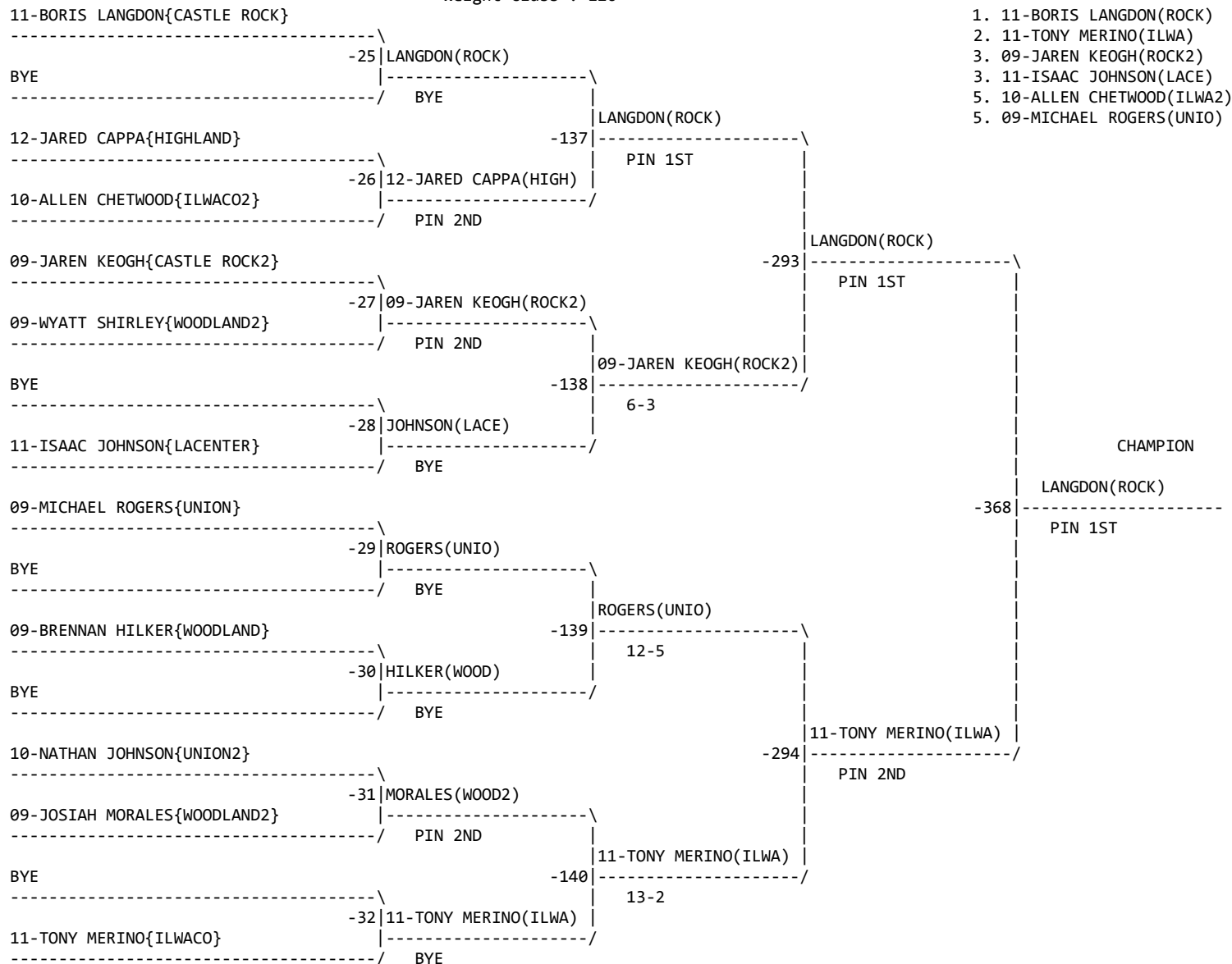

1. 11-BORIS LANGDON(ROCK)
2. 11-TONY MERINO(ILWA)
3. 09-JAREN KEOGH(ROCK2)
3. 11-ISAAC JOHNSON(LACE)
5. 10-ALLEN CHETWOOD(ILWA2)
5. 09-MICHAEL ROGERS(UNIO)



Consolation for Weight class : 126

		MORALES(WOOD2)		09-JAREN KEOGH(ROCK2)	
		-----\		-----\	
BYE		L-140		L-293	
-----\		CHETWOOD(ILWA2)			
L-25		-237			
-----\		CHETWOOD(ILWA2)			
CHETWOOD(ILWA2)	-141	BYE			
-----\					
L-26		HILKER(WOOD)			
-----\					
SHIRLEY(WOOD2)		L-139			
-----\		HILKER(WOOD)			
L-27		-238			
-----\		SHIRLEY(WOOD2)			
BYE	-142	BYE			
-----\					
L-28		JOHNSON(LACE)			
-----\					
BYE		L-138			
-----\		JOHNSON(LACE)			
L-29		-239			
-----\		BYE			
BYE	-143	BYE			
-----\					
L-30		12-JARED CAPP(AHIGH)			
-----\					
JOHNSON(UNIO2)		L-137			
-----\		12-JARED CAPP(AHIGH)			
L-31		-240			
-----\		JOHNSON(UNIO2)			
BYE	-144	BYE			
-----\					
L-32					

42ND ANNUAL JIM BAIR INVITATIONAL

Weight class : 132

- 1. 12-ALEX LANGDON(ROCK)
- 2. 11-CODY MILLER(STEV)
- 3. 09-WAYNE BAKER(ROCK2)
- 3. 12-HYRUM ROBINSON(MARK)
- 5. 10-GAGE OLSEN(EATO)
- 5. 10-GRANT HOLDAHL(WOOD)

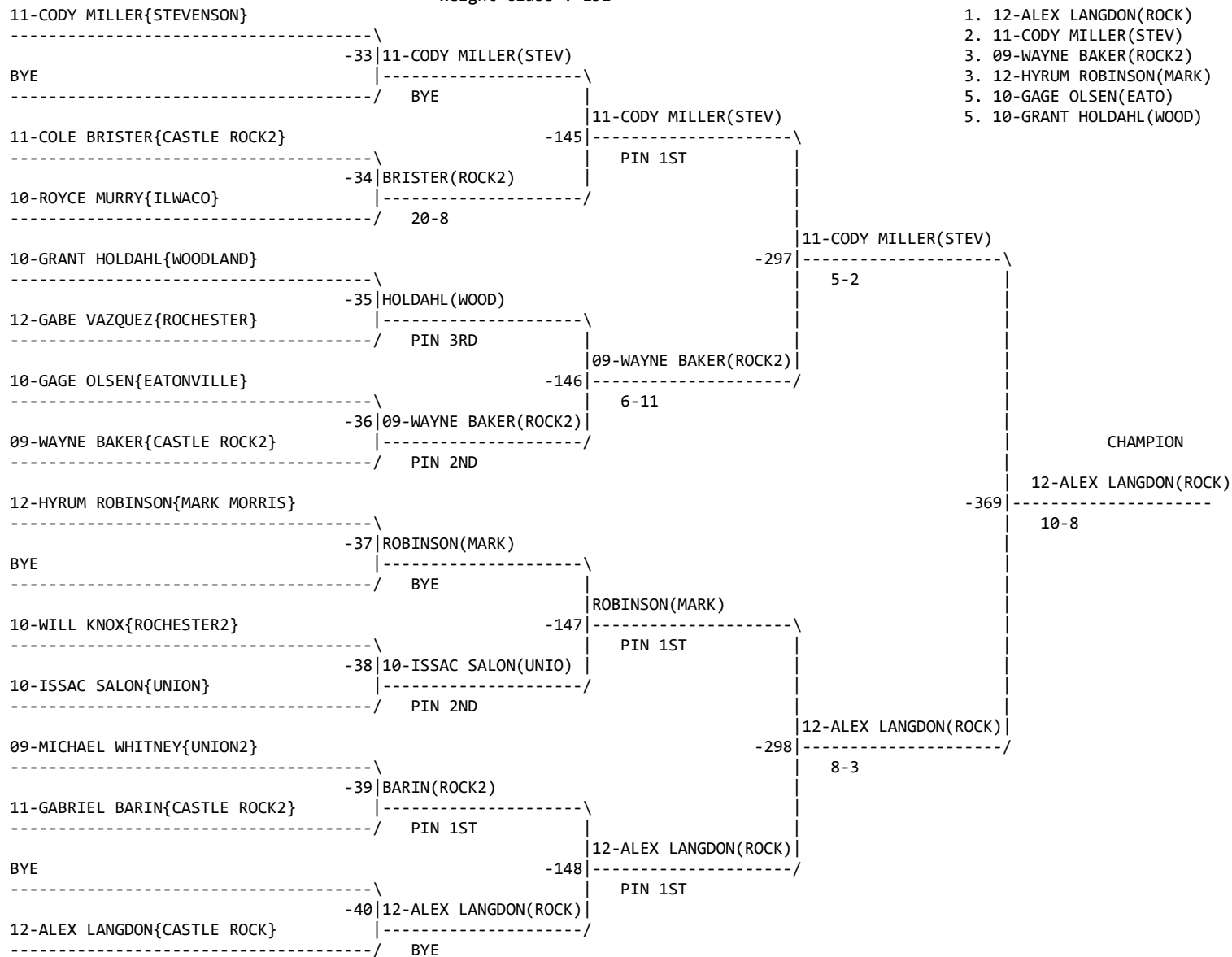

Consolation for Weight class : 132

		BARIN(ROCK2)		09-WAYNE BAKER(ROCK2)	
		-----\		-----\	
BYE		L-148	10-ROYCE MURRY(ILWA)	L-297	Third
-----\		-241	-----\		09-WAYNE BAKER(ROCK2)
L-33		10-ROYCE MURRY(ILWA)	5-2		-345
-149		-----/			-----/
10-ROYCE MURRY(ILWA)		BYE		10-GAGE OLSEN(EATO)	6-2
-----/				-----/	
L-34		10-ISSAC SALON(UNIO)		8-0	
-----\					
12-GABE VAZQUEZ(ROCH)		L-147	10-GAGE OLSEN(EATO)		
-----\		-242	-----\		
L-35		10-GAGE OLSEN(EATO)	PIN 3RD		
-150		-----/			
10-GAGE OLSEN(EATO)		PIN 2ND			
-----/					
L-36		HOLDAHL(WOOD)		ROBINSON(MARK)	
-----\				-----\	
BYE		L-146	HOLDAHL(WOOD)	L-298	Third
-----\		-243	-----\		ROBINSON(MARK)
L-37		10-WILL KNOX(ROCH2)	PIN 2ND		-346
-151		-----/			-----/
10-WILL KNOX(ROCH2)		BYE		HOLDAHL(WOOD)	10-0
-----/				-----/	
L-38		BRISTER(ROCK2)		3-2	
-----\					
WHITNEY(UNIO2)		L-145	BRISTER(ROCK2)		
-----\		-244	-----\		
L-39		WHITNEY(UNIO2)	PIN 2ND		
-152		-----/			
BYE		BYE			
-----/					
L-40					

42ND ANNUAL JIM BAIR INVITATIONAL

Weight class : 138

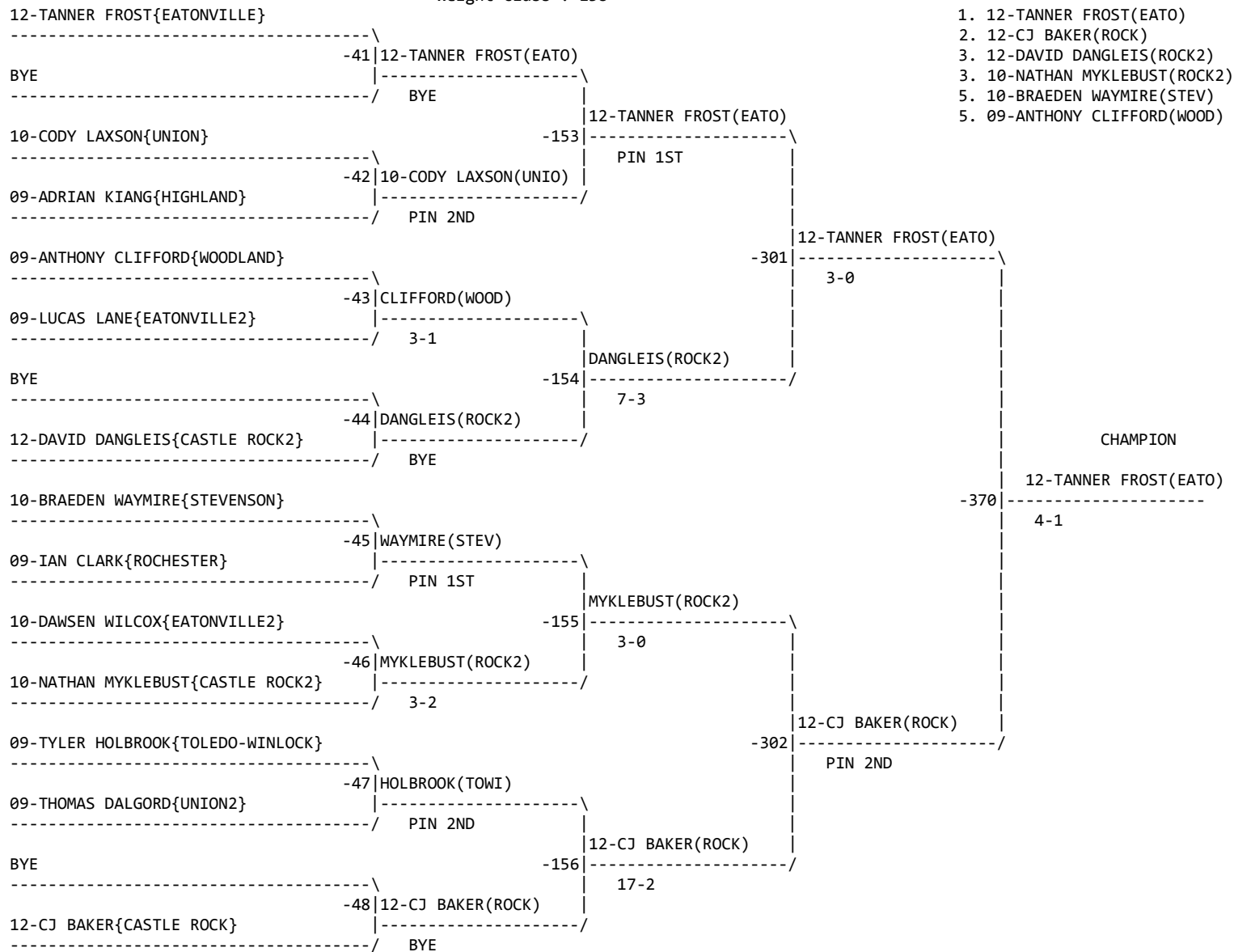

1. 12-TANNER FROST(EATO)
2. 12-CJ BAKER(ROCK)
3. 12-DAVID DANGLEIS(ROCK2)
3. 10-NATHAN MYKLEBUST(ROCK2)
5. 10-BRAEDEN WAYMIRE(STEV)
5. 09-ANTHONY CLIFFORD(WOOD)

CHAMPION

Consolation for Weight class : 138

Weight	Participant	Score	Participant	Score	Participant	Score
	HOLBROOK(TOWI)		DANGLEIS(ROCK2)			
	L-156		L-301		Third	
BYE						
	L-156	-245				
L-41	09-ADRIAN KIANG(HIGH)				DANGLEIS(ROCK2)	
						12-1
	09-ADRIAN KIANG(HIGH)	-157				
	BYE					
L-42	WAYMIRE(STEV)					
	09-LUCAS LANE(EATO2)					
	L-155	-246				
L-43	09-LUCAS LANE(EATO2)					
	09-LUCAS LANE(EATO2)	-158				
	BYE					
L-44	CLIFFORD(WOOD)					
	09-IAN CLARK(ROCH)					
	L-154	-247				
L-45	WILCOX(EATO2)					
	WILCOX(EATO2)	-159				
	PIN 1ST					
L-46	10-CODY LAXSON(UNIO)					
	DALGORD(UNIO2)					
	L-153	-248				
L-47	DALGORD(UNIO2)					
	DALGORD(UNIO2)	-160				
	BYE					
L-48						

42ND ANNUAL JIM BAIR INVITATIONAL

Weight class : 145

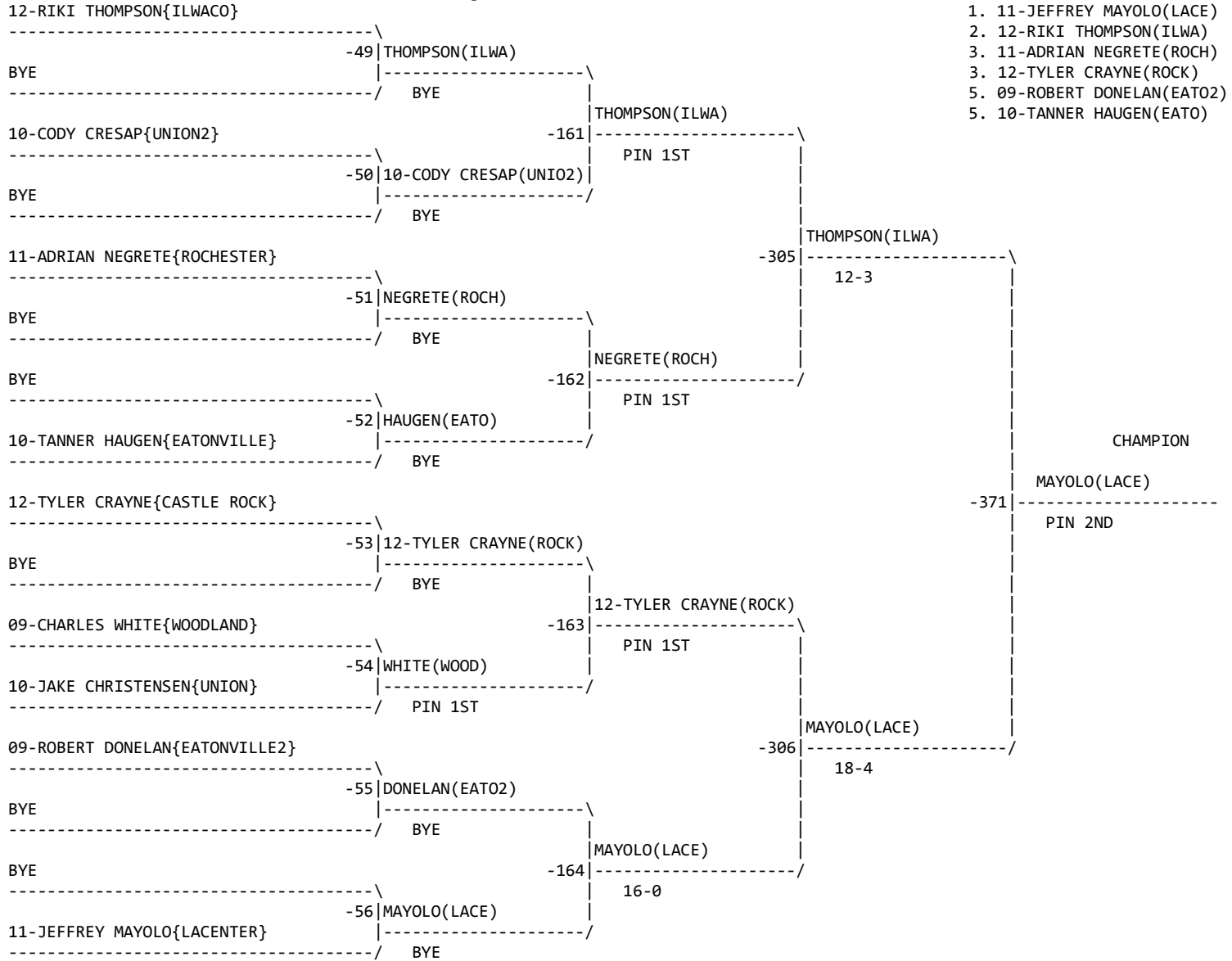

Consolation for Weight class : 145

	DONELAN(EATO2)		NEGRETE(ROCH)	
	-----\		-----\	
BYE	L-164		L-305	Third
-----\		DONELAN(EATO2)		
L-49	BYE	-249	BYE	-349
-----\				NEGRETE(ROCH)
BYE	-165	BYE		PIN 2ND
-----\			DONELAN(EATO2)	
L-50	WHITE(WOOD)		8-4	
-----\				
BYE	L-163		WHITE(WOOD)	
-----\				
L-51	BYE	-250	BYE	
-----\				
BYE	-166	BYE		
-----\				
L-52	HAUGEN(EATO)		12-TYLER CRAYNE(ROCK)	
-----\			-----\	
BYE	L-162		L-306	Third
-----\		HAUGEN(EATO)		
L-53	CHRISTENSEN(UNIO)	-251	16-0	-350
-----\				12-TYLER CRAYNE(ROCK)
CHRISTENSEN(UNIO)	BYE			PIN 2ND
-----\			HAUGEN(EATO)	
L-54	10-CODY CRESAP(UNIO2)		PIN 1ST	
-----\				
BYE	L-161		10-CODY CRESAP(UNIO2)	
-----\				
L-55	BYE	-252	BYE	
-----\				
BYE	-168	BYE		
-----\				
L-56				

42ND ANNUAL JIM BAIR INVITATIONAL

Weight class : 152

1. 11-CHRIS MILLWARD(ROCK)
2. 12-JOE LOPEZ(ILWA)
3. 12-TRISTIN HUSS(LACE)
3. 11-JESSE HOFFBERGER(STEV)
5. 10-AUSTIN HUYNH(UNIO)
5. 10-NOAH HADFIELD(UNIO2)

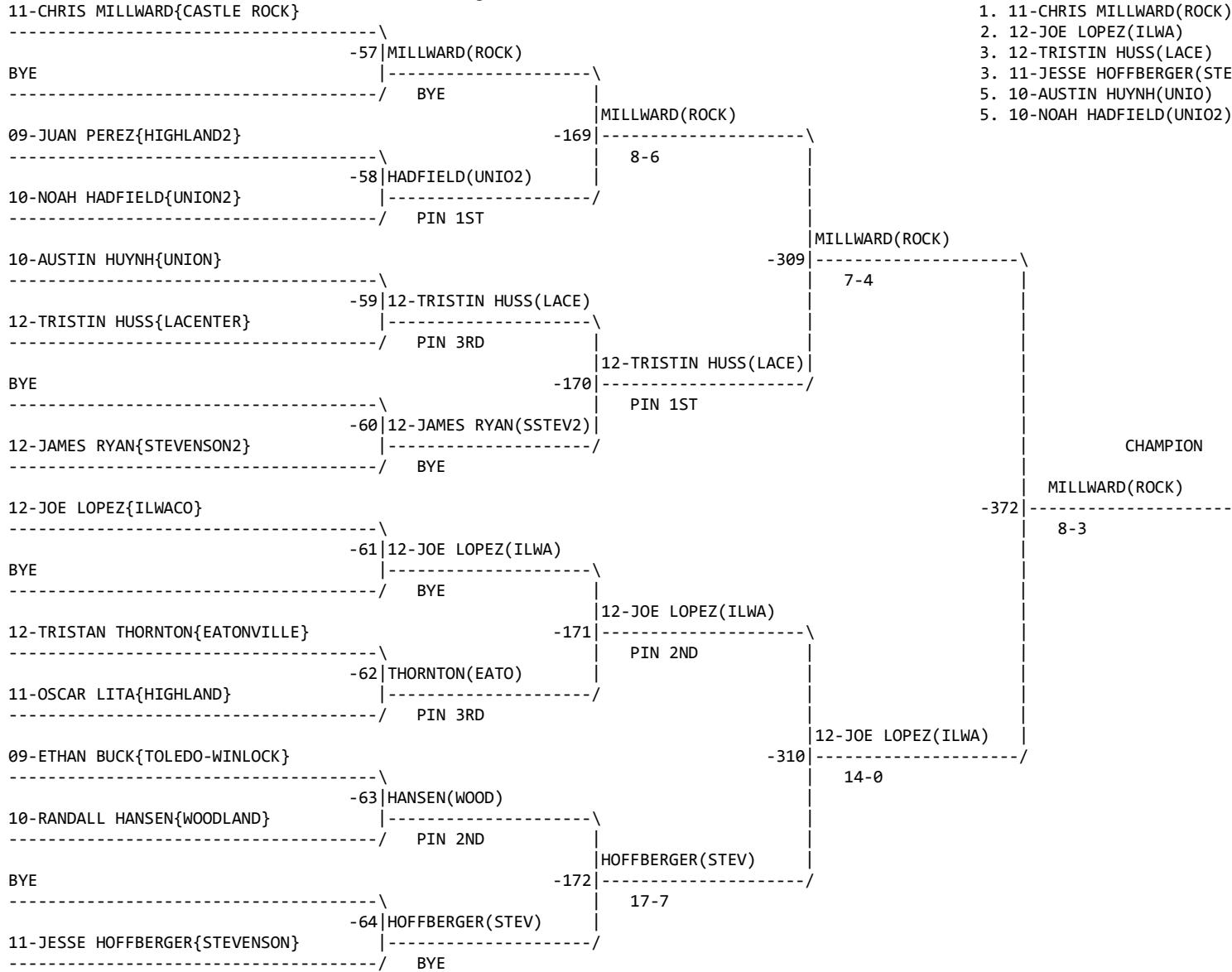



Consolation for Weight class : 152

	HANSEN(WOOD)		12-TRISTIN HUSS(LACE)	
	-----\		-----\	
BYE	L-172	HANSEN(WOOD)	L-309	Third
-----\	-----\	-----\	-----\	-----\
L-57	09-JUAN PEREZ(HIGH2)	PIN 1ST	12-TRISTIN HUSS(LACE)	5-0
-173	-----/	-----/	-351	-----/
09-JUAN PEREZ(HIGH2)	BYE		10-AUSTIN HUYNH(UNIO)	
-----/	-----/	-----/	-----/	-----/
L-58	THORNTON(EATO)		PIN 2ND	
-----\	-----\	-----\	-----\	-----\
10-AUSTIN HUYNH(UNIO)	L-171	10-AUSTIN HUYNH(UNIO)		
-----\	-----\	-----\	-----\	-----\
L-59	10-AUSTIN HUYNH(UNIO)	PIN 2ND		
-174	-----/	-----/		
BYE	BYE			
-----/	-----/	-----/	-----/	-----/
L-60	12-JAMES RYAN(SSTEVE2)		HOFFBERGER(STEV)	
-----\	-----\	-----\	-----\	-----\
BYE	L-170	12-JAMES RYAN(SSTEVE2)	L-310	Third
-----\	-----\	-----\	-----\	-----\
L-61	11-OSCAR LITA(HIGH)	PIN 3RD	HOFFBERGER(STEV)	
-175	-----/	-----/	-352	-----/
11-OSCAR LITA(HIGH)	BYE		HADFIELD(UNIO2)	PIN 2ND
-----/	-----/	-----/	-----/	-----/
L-62	HADFIELD(UNIO2)		9-3	
-----\	-----\	-----\	-----\	-----\
09-ETHAN BUCK(TOWI)	L-169	HADFIELD(UNIO2)		
-----\	-----\	-----\	-----\	-----\
L-63	09-ETHAN BUCK(TOWI)	PIN 2ND		
-176	-----/	-----/		
BYE	BYE			
-----/	-----/	-----/	-----/	-----/
L-64				

42ND ANNUAL JIM BAIR INVITATIONAL

Weight class : 160

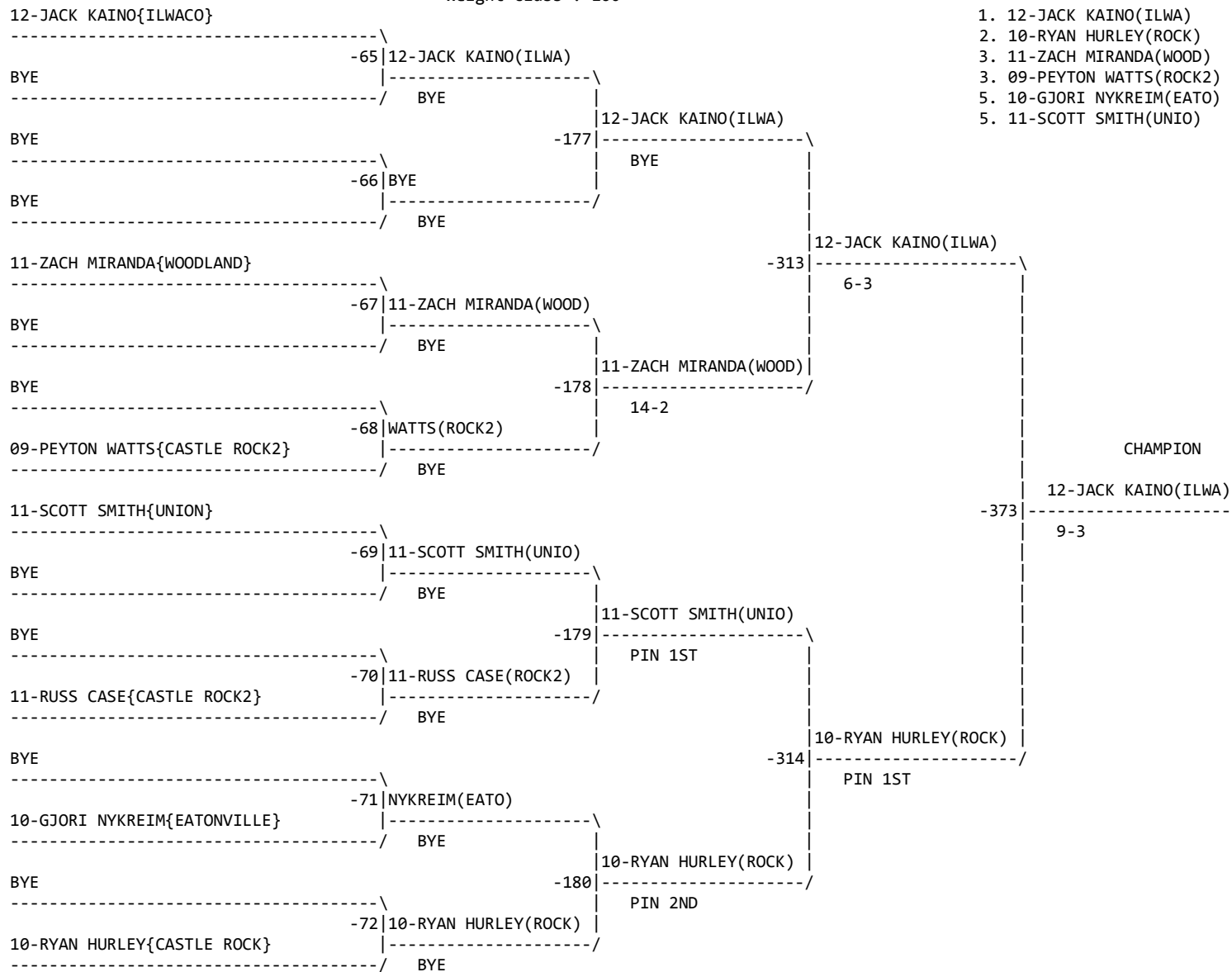

1. 12-JACK KAINO(ILWA)
2. 10-RYAN HURLEY(ROCK)
3. 11-ZACH MIRANDA(WOOD)
3. 09-PEYTON WATTS(ROCK2)
5. 10-GJORI NYKREIM(EATO)
5. 11-SCOTT SMITH(UNIO)

CHAMPION

12-JACK KAINO(ILWA)

9-3

Consolation for Weight class : 160

```

                                     NYKREIM(EATO)
                                     -----\
BYE                                 L-180      |NYKREIM(EATO)
-----\                               |
L-65   |BYE                               |
-181   |-----\                         |
BYE    |BYE                               |
-----/                               |
L-66   |11-RUSS CASE(ROCK2)              |
-----\                               |
BYE    |L-179                            |11-RUSS CASE(ROCK2)
-----\                               |
L-67   |BYE                               |
-182   |-----\                         |
BYE    |BYE                               |
-----/                               |
L-68   |WATTS(ROCK2)                    |
-----\                               |
BYE    |L-178                            |WATTS(ROCK2)
-----\                               |
L-69   |BYE                               |
-183   |-----\                         |
BYE    |BYE                               |
-----/                               |
L-70   |BYE                               |
-----\                               |
BYE    |L-177                            |BYE
-----\                               |
L-71   |BYE                               |
-184   |-----\                         |
BYE    |BYE                               |
-----/                               |
L-72   |
-----/

11-ZACH MIRANDA(WOOD)
-----\
L-313   |
-----\
Third  |
-----\
11-ZACH MIRANDA(WOOD)
-----\
10-2   |
-----/

NYKREIM(EATO)
-----\
-315   |
-----/
PIN 2ND

11-SCOTT SMITH(UNIO)
-----\
L-314   |
-----\
Third  |
-----\
WATTS(ROCK2)
-----\
PIN 1ST
-----/

WATTS(ROCK2)
-----\
-259   |
-----\
BYE    |BYE
-----/

WATTS(ROCK2)
-----\
-316   |
-----/
BYE

WATTS(ROCK2)
-----\
-260   |
-----\
BYE    |BYE
-----/

WATTS(ROCK2)
-----\
-184   |
-----/
BYE
```

42ND ANNUAL JIM BAIR INVITATIONAL

Weight class : 170

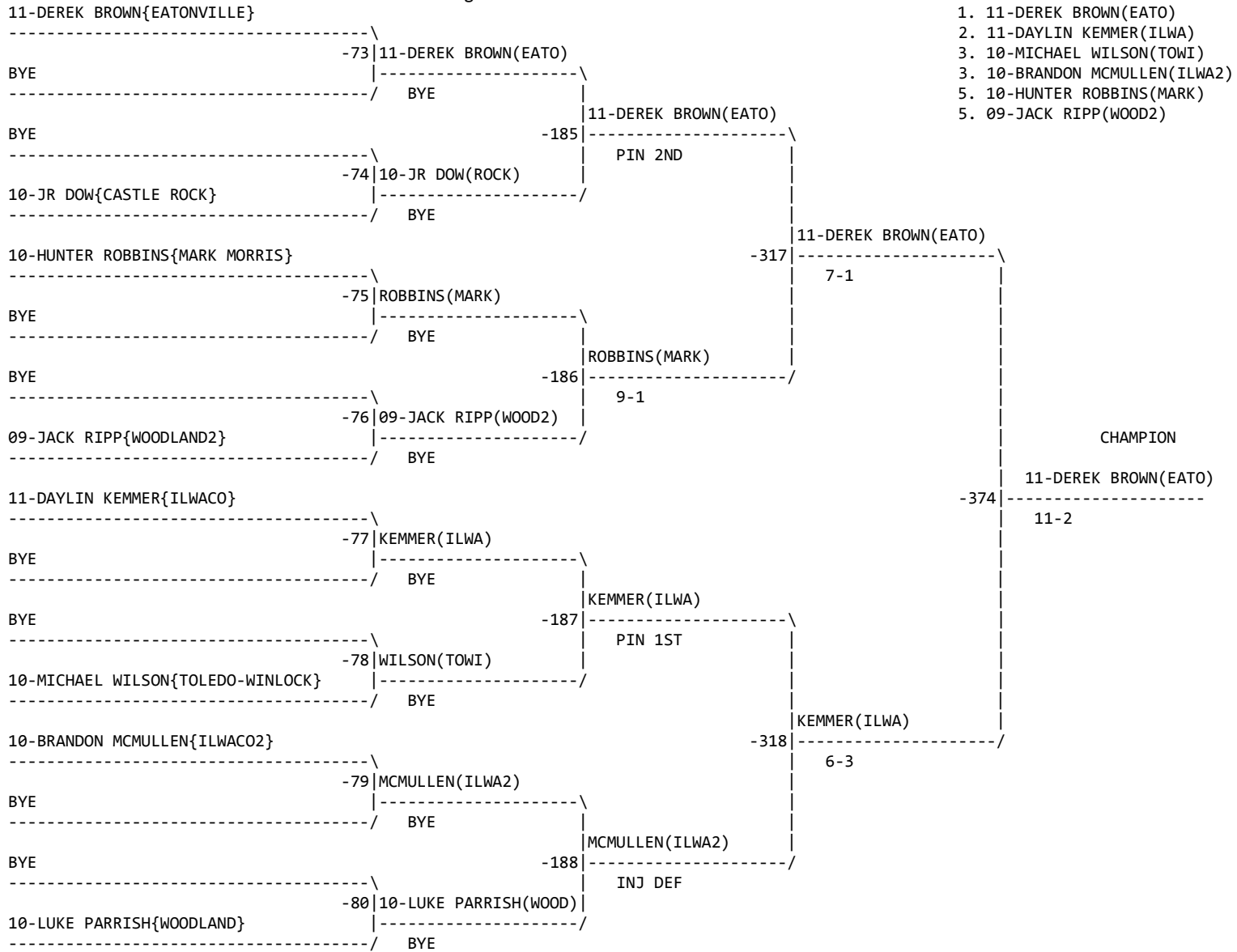

Consolation for Weight class : 170

		10-LUKE PARRISH(WOOD)		ROBBINS(MARK)	
		-----\		-----\	
		L-188		L-317	Third
BYE					
-----\		-261	10-LUKE PARRISH(WOOD)	-----\	WILSON(TOWI)
L-73	BYE		BYE		-355
-----\	-189	-----/	-----/	-----\	PIN 1ST
BYE					
-----\		BYE		WILSON(TOWI)	
L-74					
-----\		WILSON(TOWI)		-----\	
BYE					
-----\		L-187		WILSON(TOWI)	
L-75	BYE		BYE		
-----\	-190	-262	-----/	-----\	
BYE					
-----\		BYE		INJ DEF	
L-76				-----\	
-----\		09-JACK RIPP(WOOD2)		MCMULLEN(ILWA2)	
BYE		-----\		-----\	
-----\		L-186		L-318	Third
L-77	BYE		09-JACK RIPP(WOOD2)		
-----\	-191	-263	-----/	-----\	MCMULLEN(ILWA2)
BYE			BYE		-356
-----\		BYE		09-JACK RIPP(WOOD2)	PIN 2ND
L-78				-----\	
-----\		10-JR DOW(ROCK)			
BYE		-----\			
-----\		L-185		4-2	
L-79	BYE		10-JR DOW(ROCK)		
-----\	-192	-264	-----/	-----\	
BYE			BYE		
-----\		BYE			
L-80					

42ND ANNUAL JIM BAIR INVITATIONAL

Weight class : 182

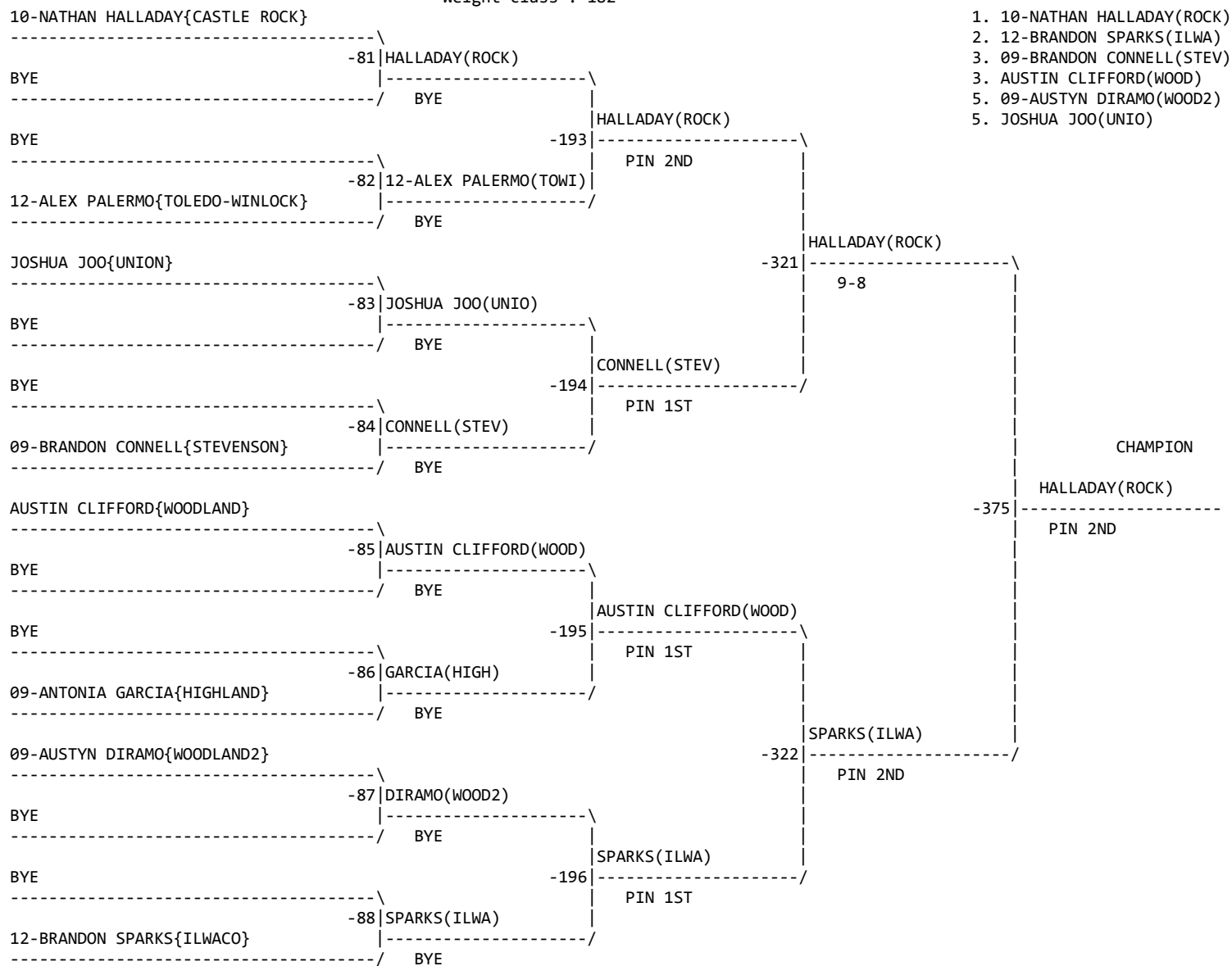

Consolation for Weight class : 182

	DIRAMO(WOOD2)		CONNELL(STEV)	
	L-196		L-321	
BYE		DIRAMO(WOOD2)		Third
-----\	-----\	-----\	-----\	-----\
L-81	BYE	-265	BYE	-357
-----/	-----/	-----/	-----/	-----/
BYE	BYE		DIRAMO(WOOD2)	PIN 1ST
-----/	-----/	-----/	-----/	-----/
L-82	GARCIA(HIGH)		PIN 2ND	
-----\	-----\	-----\	-----\	-----\
BYE	L-195	GARCIA(HIGH)		
-----\	-----\	-----\	-----\	-----\
L-83	BYE	-266	BYE	
-----/	-----/	-----/	-----/	-----/
BYE	BYE			
-----/	-----/	-----/	-----/	-----/
L-84	JOSHUA JOO(UNIO)		AUSTIN CLIFFORD(WOOD)	
-----\	-----\	-----\	-----\	-----\
BYE	L-194	JOSHUA JOO(UNIO)	L-322	Third
-----\	-----\	-----\	-----\	-----\
L-85	BYE	-267	BYE	-358
-----/	-----/	-----/	-----/	-----/
BYE	BYE		JOSHUA JOO(UNIO)	PIN 2ND
-----/	-----/	-----/	-----/	-----/
L-86	12-ALEX PALERMO(TOWI)		PIN 3RD	
-----\	-----\	-----\	-----\	-----\
BYE	L-193	12-ALEX PALERMO(TOWI)		
-----\	-----\	-----\	-----\	-----\
L-87	BYE	-268	BYE	
-----/	-----/	-----/	-----/	-----/
BYE	BYE			
-----/	-----/	-----/	-----/	-----/
L-88				

42ND ANNUAL JIM BAIR INVITATIONAL

Weight class : 195

12-TALIB MEEKS{CASTLE ROCK}

-----\
-89|12-TALIB MEEKS(ROCK)
BYE |-----\
-----/ BYE |

BYE -201|12-TALIB MEEKS(ROCK)
-----\
-90|BYE
BYE |-----\
-----/ BYE |

BYE -91|BYE
-----\
BYE |-----\
-----/ BYE |

BYE -202|BYE
-----\
-92|BYE
BYE |-----\
-----/ BYE |

10-DAMIAN APARICIA{WOODLAND}

-----\
-93|APARICIA(WOOD)-
BYE |-----\
-----/ BYE |

BYE -203|APARICIA(WOOD)-
-----\
-94|BYE
BYE |-----\
-----/ BYE |

BYE -95|BYE
-----\
BYE |-----\
-----/ BYE |

BYE -204|KELLOGG(ILWA)
-----\
-96|KELLOGG(ILWA)
BYE |-----\
-----/ BYE |

12-DeANTAY KELLOGG{ILWACO}

-----\
-96|KELLOGG(ILWA)
BYE |-----\
-----/ BYE |

- 1. 12-TALIB MEEKS(ROCK)
2. 12-DeANTAY KELLOGG(ILWA)
3. BYE
3. 10-DAMIAN APARICIA(WOOD)-
5. BYE
5. BYE

12-TALIB MEEKS(ROCK)
-325|
-----\
BYE |

BYE -326|
-----\
BYE |

12-TALIB MEEKS(ROCK)
-376|
-----\
PIN 1ST |

KELLOGG(ILWA)
-326|
-----\
PIN 1ST |

BYE -204|
-----\
BYE |

CHAMPION

12-TALIB MEEKS(ROCK)

PIN 1ST

KELLOGG(ILWA)

PIN 1ST

KELLOGG(ILWA)

BYE



Consolation for Weight class : 195

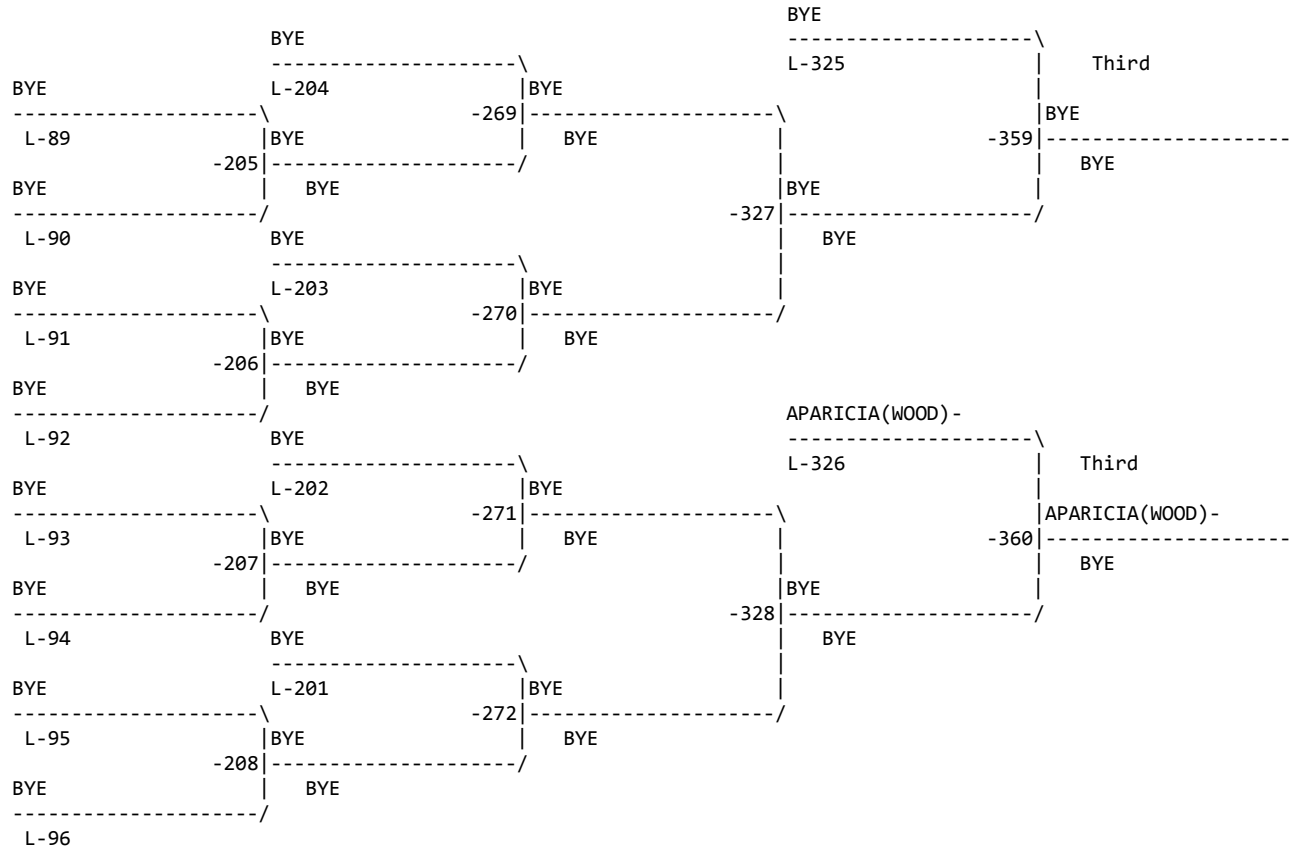

42ND ANNUAL JIM BAIR INVITATIONAL

Weight class : 220

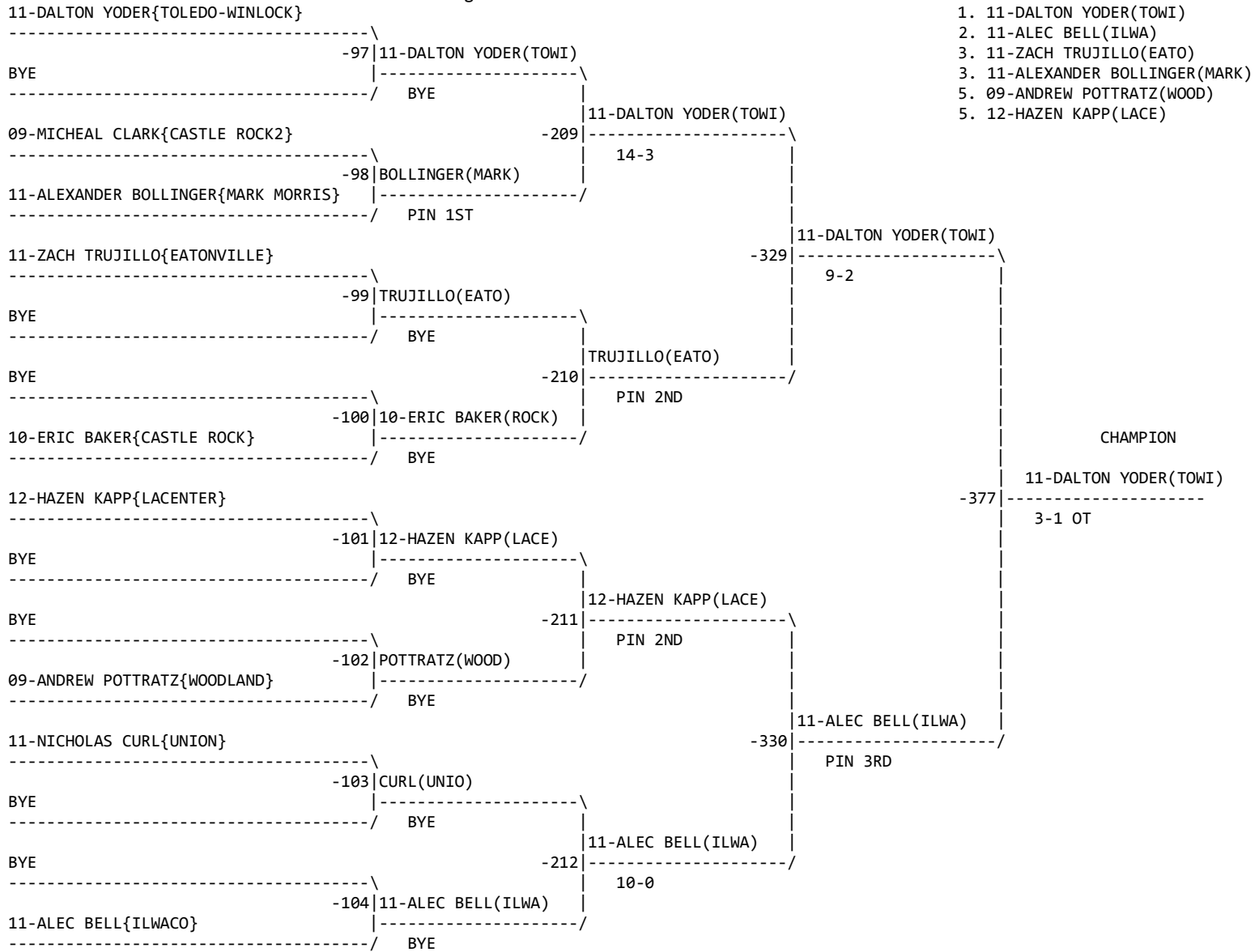

1. 11-DALTON YODER(TOWI)
2. 11-ALEC BELL(ILWA)
3. 11-ZACH TRUJILLO(EATO)
3. 11-ALEXANDER BOLLINGER(MARK)
5. 09-ANDREW POTTRATZ(WOOD)
5. 12-HAZEN KAPP(LACE)

Consolation for Weight class : 220

				TRUJILLO(EATO)	
	CURL(UNIO)			L-329	Third
BYE	L-212	CURL(UNIO)			
-----\		-273	-----\		TRUJILLO(EATO)
L-97	CLARK(ROCK2)			-361	PIN 2ND
-213		-----/			
CLARK(ROCK2)	BYE		POTTRATZ(WOOD)		
-----/			-331		
L-98	POTTRATZ(WOOD)				INJ DEF
-----\					
BYE	L-211	POTTRATZ(WOOD)			
-----\		-274	-----/		
L-99	BYE				BYE
-214		-----/			
BYE	BYE				
-----/					
L-100	10-ERIC BAKER(ROCK)		12-HAZEN KAPP(LACE)		
			L-330		Third
BYE	L-210	10-ERIC BAKER(ROCK)			
-----\		-275	-----\		BOLLINGER(MARK)
L-101	BYE			-362	14-0
-215		-----/			
BYE	BYE		BOLLINGER(MARK)		
-----/			-332		
L-102	BOLLINGER(MARK)				PIN3RD
-----\					
BYE	L-209	BOLLINGER(MARK)			
-----\		-276	-----/		
L-103	BYE				BYE
-216		-----/			
BYE	BYE				
-----/					
L-104					

42ND ANNUAL JIM BAIR INVITATIONAL

Weight class : 285

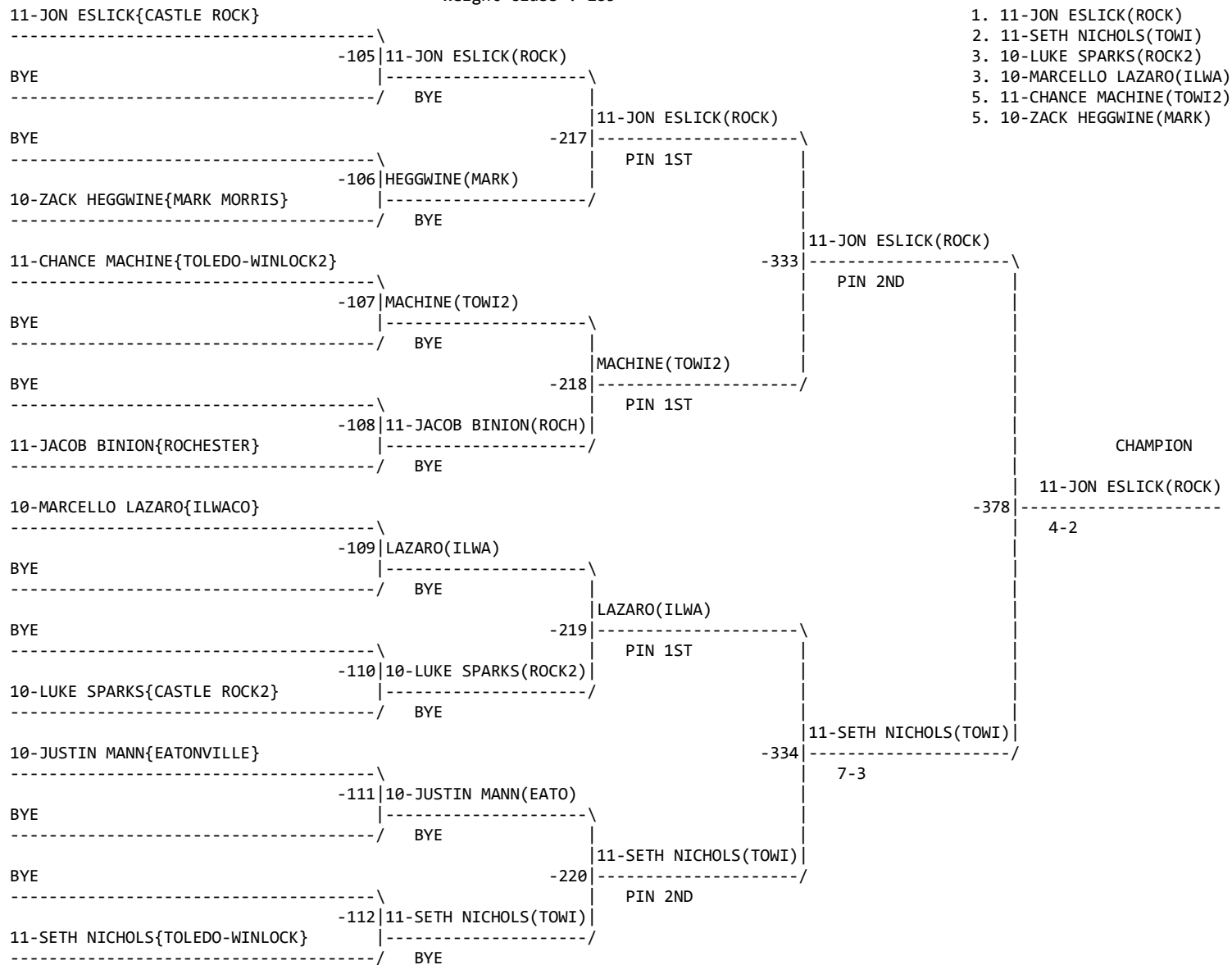

1. 11-JON ESLICK(ROCK)
2. 11-SETH NICHOLS(TOWI)
3. 10-LUKE SPARKS(ROCK2)
3. 10-MARCELLO LAZARO(ILWA)
5. 11-CHANCE MACHINE(TOWI2)
5. 10-ZACK HEGGWINE(MARK)

CHAMPION

11-JON ESLICK(ROCK)  
4-2

7-3

Consolation for Weight class : 285

				MACHINE(TOWI2)		
		10-JUSTIN MANN(EATO)		-----\		
		L-220		L-333		Third
BYE			10-JUSTIN MANN(EATO)			
-----\		-277	-----\			
L-105	BYE		BYE		-363	10-LUKE SPARKS(ROCK2)
-----\	-221		-----\		-----\	
BYE		BYE		10-LUKE SPARKS(ROCK2)		PIN 2ND
-----\		-----\		-----\		
L-106		10-LUKE SPARKS(ROCK2)		PIN 1ST		
-----\		L-219				
BYE			10-LUKE SPARKS(ROCK2)			
-----\		-278	-----\			
L-107	BYE		BYE			
-----\	-222		-----\			
BYE		BYE				
-----\		-----\				
L-108		11-JACOB BINION(ROCH)		LAZARO(ILWA)		
-----\		L-218		-----\		
BYE			11-JACOB BINION(ROCH)			Third
-----\		-279	-----\			
L-109	BYE		BYE		-364	LAZARO(ILWA)
-----\	-223		-----\		-----\	
BYE		BYE		HEGGWINE(MARK)		PIN 1ST
-----\		-----\		-----\		
L-110		HEGGWINE(MARK)		PIN 1ST		
-----\		L-217				
BYE			HEGGWINE(MARK)			
-----\		-280	-----\			
L-111	BYE		BYE			
-----\	-224		-----\			
BYE		BYE				
-----\		-----\				
L-112						